

## Tube Formation Assays in $\mu$ -Slide Angiogenesis

### Contents

1. General Information.....	1
2. Material .....	2
3. Work Flow Overview.....	3
4. Preparation of the Gel and the Slide .....	4
4.1. Gel Application.....	4
4.2. How to Adjust the Right Volume of Gel .....	5
4.3. Gelation .....	5
5. Seeding Cells.....	6
5.1. Control the Right Cell Number! .....	7
6. Observation on the Microscope .....	7
6.1. Automatical Observation .....	7
6.2. Manual Observation .....	8
7. Data Analysis and Interpretation.....	8
8. Staining Protocol.....	9

### 1. General Information

The  $\mu$ -Slide Angiogenesis is designed for observing tube formation on an inverted microscope. It can be used with all common 3D gel matrices, such as Matrigel<sup>®</sup>, collagen gels, and hyaluronic acid gels. Only 10  $\mu$ l of gel per well are needed.

The platform provided by the  $\mu$ -Slide Angiogenesis eliminates the meniscus effect, which is often observed in standard well formats. Using the  $\mu$ -Slide Angiogenesis, every cell on the flat gel surface is visible with high-quality phase contrast or fluorescence microscopy.

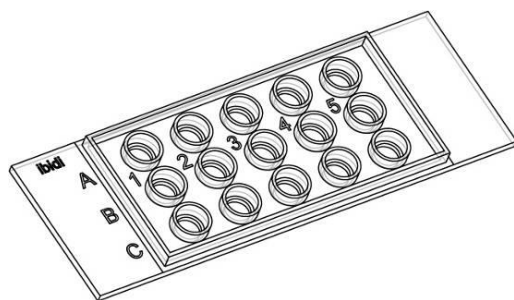

$\mu$ -Slide Angiogenesis

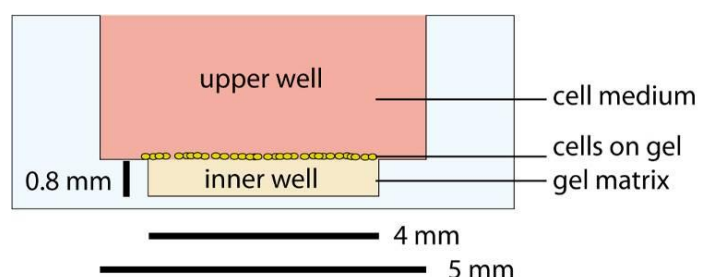

Cross section of one well

This application note describes a sample setup with the  $\mu$ -Slide Angiogenesis for a tube formation assay with endothelial cells (HUVEC) on Matrigel<sup>®</sup>.

## 2. Material

Cells:	HUVEC (PromoCell, C-12200, C-12203)	10 <sup>4</sup> per well
Medium:	Endothelial Cell Growth Medium (PromoCell, C-22010)	50 µl per well
Gel matrix:	Matrigel® Growth Factor Reduced, Phenol Red-Free (Corning® #356231)	10 µl per well
Slides:	µ-Slide Angiogenesis, ibiTreat (ibidi, 81506)	1 Slide
Fluorescence stain:	Calcein AM (PromoKine, PK-CA707-80011)	1 ml (6.25 µg/ml)
Other:	Scale paper for checking the perfect volume	1 sheet
Detach reagent	Accutase (PromoCell, C-41310)	8 ml per T75 flask

For easy handling, the wells are compatible with multi-channel pipettes. The plastic is compatible with various fixing solutions, such as isopropanol, methanol, paraformaldehyde, and others. The optical properties of the plastic bottom are comparable to those of glass coverslips.

**NOTE: The expression “tubes” describes the cords of cells that are visible in a formed network. It does not indicate, specifically, that the cords have a lumen.**

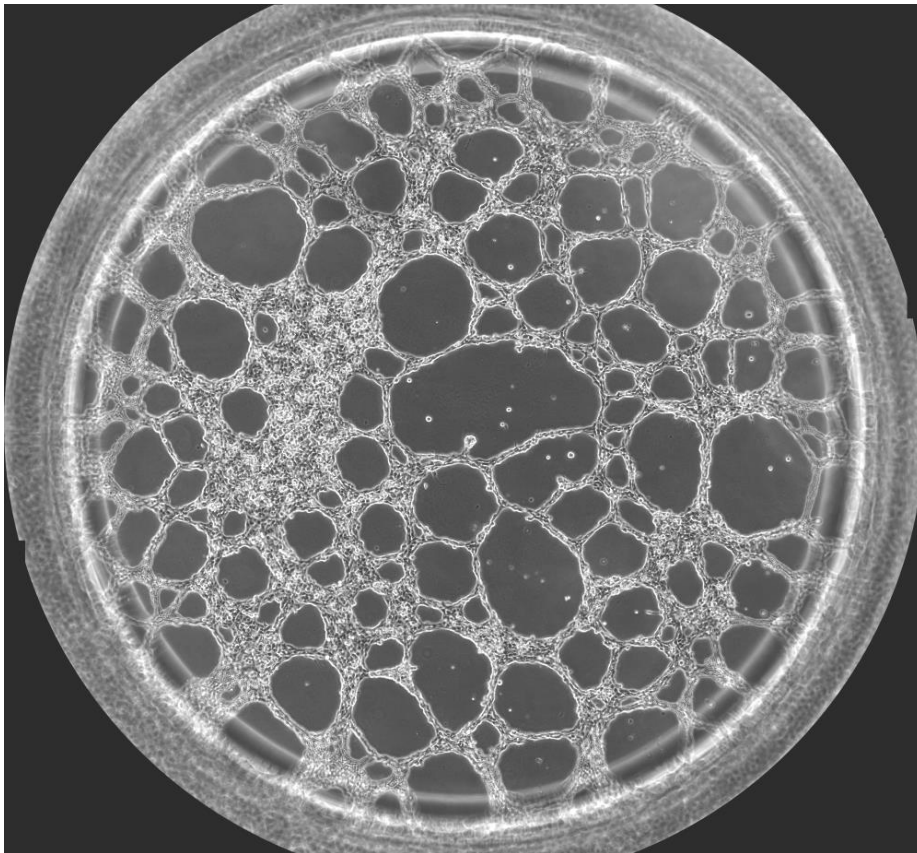

**Phase contrast image with a 10x objective (arranged of 5x6 single images) which shows an entire well with HUVECs that are forming a cell network. The image was taken 10 hours after seeding. The diameter of the well is 4 mm.**

### 3. Work Flow Overview

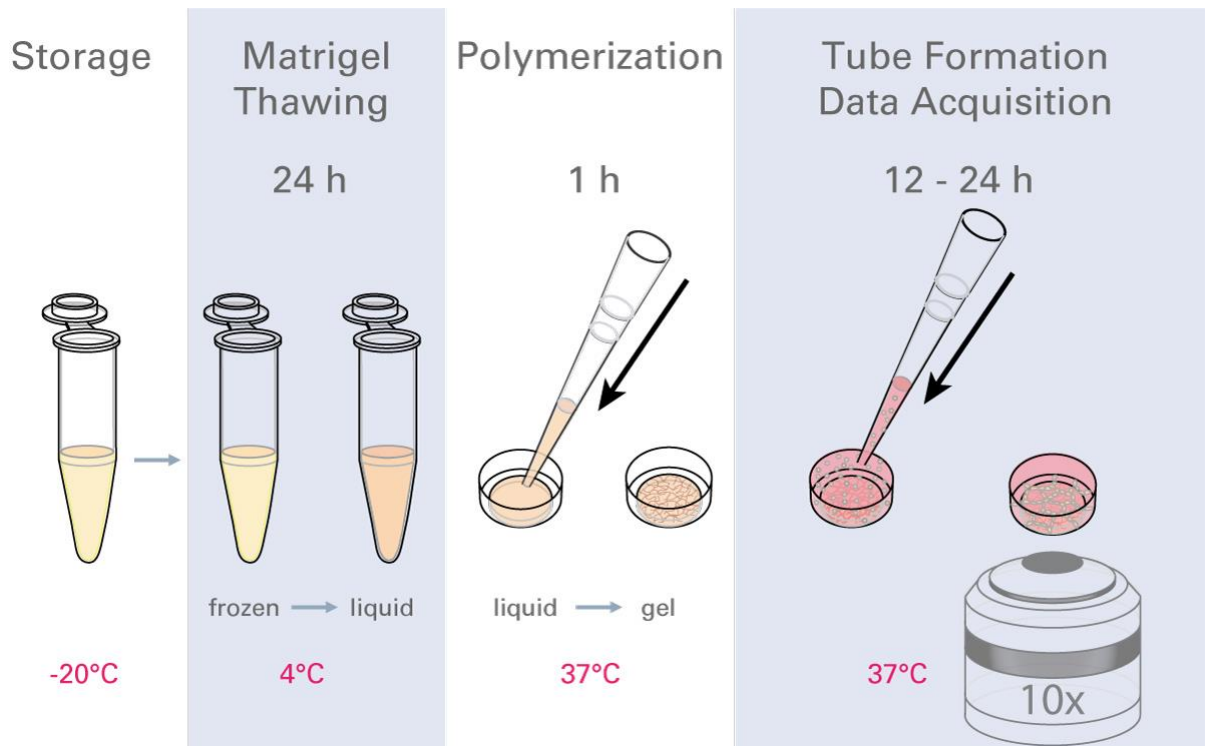

#### Data Acquisition

6 - 24 h

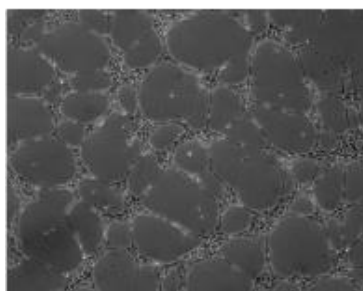

Phase Contrast or  
Fluorescence  
Images

#### Data Analysis

15 min

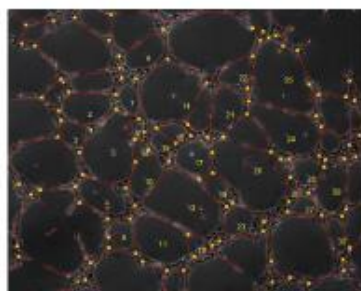

Automated Image  
Analysis  
(ACAS)

#### Data Interpretation

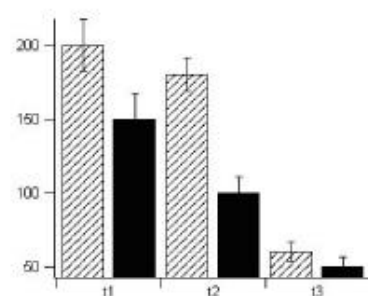

Statistical Tests of  
Stimulated and  
Control Data

## 4. Preparation of the 3D Gel and the Slide

### 4.1. Gel Application

Follow these steps:

- 1) The day before seeding cells, place the Matrigel® on ice in the refrigerator at 4°C. The gel can slowly thaw overnight.

**Note: Always use precooled pipet tips (4°C) for pipetting the gel!**

- 2) When starting the experiment, place the vessel with the gel in a cool rack in the laminar flow hood.
- 3) Remove the  $\mu$ -Slide Angiogenesis from the sterile packing and place it on a  $\mu$ -Slide rack.
- 4) Apply 10  $\mu$ l of gel to each inner well. Hold the pipet tip upright in the middle of the well. This prevents the gel from flowing into the upper well.



#### Pipetting Tips

To avoid air bubbles, make three up and down movements (10  $\mu$ l) with the pipet while leaving the tip in the gel. Then transfer 10  $\mu$ l aliquots to the wells.

Due to the high viscosity of Matrigel®, it might be necessary to adjust the pipet volume to more or less than 10  $\mu$ l.

To control the right amount of gel, observe the scale paper through the filled wells. With an adequate volume, there is no magnification or minimization effect. If it is not correct, adjust the volume with gel (see the following page).

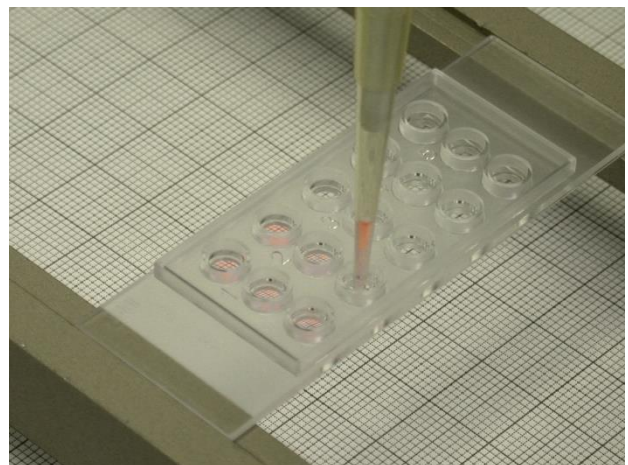

#### 4.2. How to Adjust the Right Volume of Gel

The volume of the inner well is exactly 10  $\mu\text{l}$ . When the well contains the correct volume, no magnification or demagnification effect, such as seen in the picture below, is observed. To visualize the effect, hold the slide at a distance of a few centimeters over a scale paper.

If the pipet setting of 10  $\mu\text{l}$  does not result in meniscus-free filling, try slightly different pipetting volumes and check with a scale paper to determine which setting is adequate.

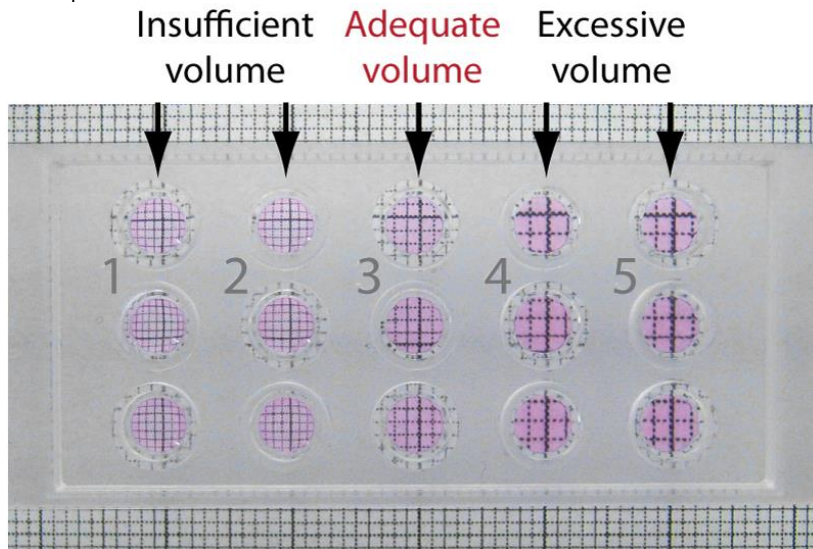

$\mu$ -Slide Angiogenesis filled with Matrigel<sup>®</sup>. Columns 1 and 2 contain less than 10  $\mu\text{l}$ . The grid looks diminished. Column 3 is filled with the adequate volume of 10  $\mu\text{l}$  and shows no shift. Columns 4 and 5 have an excessive volume. The grid is magnified.

#### 4.3. Gelation

Follow these steps:

- 1) After applying the gel, close the lid on the slide.
- 2) Prepare a petri dish with water soaked paper towels for use as an extra humidity chamber.
- 3) Place the  $\mu$ -Slide in the petri dish and close the lid.
- 4) Place the whole assembly into the incubator for polymerization (30-60 min).
- 5) In the meantime, prepare the cell suspension.

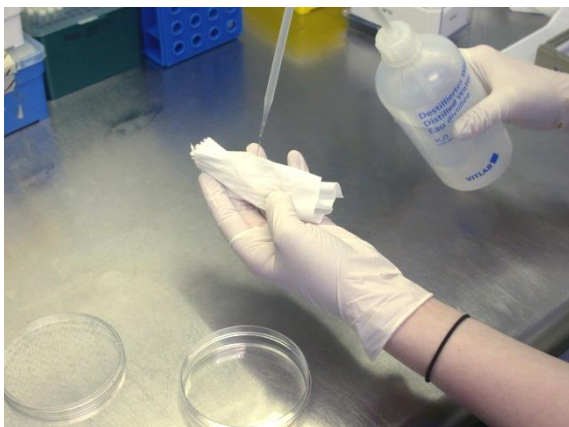

**Preparing the humidity chamber**

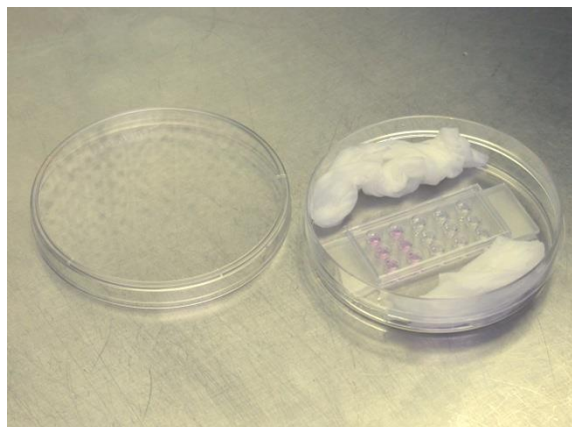

**$\mu$ -Slide placed in the humidity chamber**

## 5. Seeding Cells

The number of cells seeded on the surface of the gel is a crucial parameter for obtaining reliable results. The cell type and size determine the number of cells that are needed. For best results, optimize the cell seeding number before starting an experimental series.

Follow these steps:

- 1) For a final cell number of 10.000 cells per well, adjust a cell suspension of  $2 \times 10^5$  cells/ml. Then mix thoroughly.
- 2) Take the  $\mu$ -Slide from the incubator and place it on the rack.
- 3) Apply 50  $\mu$ l cell suspension to each upper well. Keep the pipet tip upright and take care not to touch the gel with the pipet tip. For this step a multi-channel pipet might be helpful.
- 4) Again, control the correct volume with the scale paper, as shown above. If not correct, then adjust the volume with cell-free medium.
- 5) Close the slide with the lid. The slide is now ready for observation.
- 6) After some minutes, all the cells will have sunk to the bottom of the upper well (gel surface) and will be lying in one plane. Due to the geometry of the wells the cells on the margins are placed on the plastic surface (not on the gel).

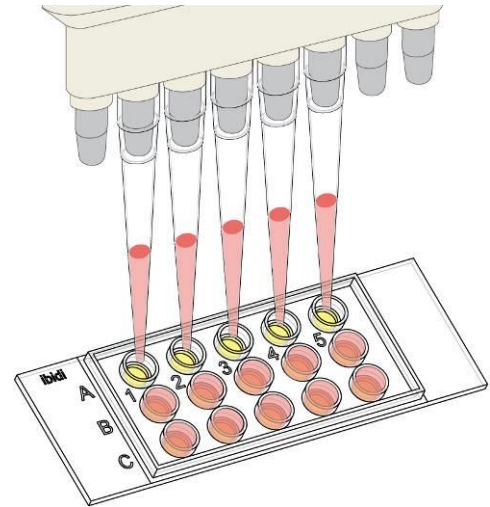

**Filling the cell suspension with a multi-channel pipet into the upper wells.**

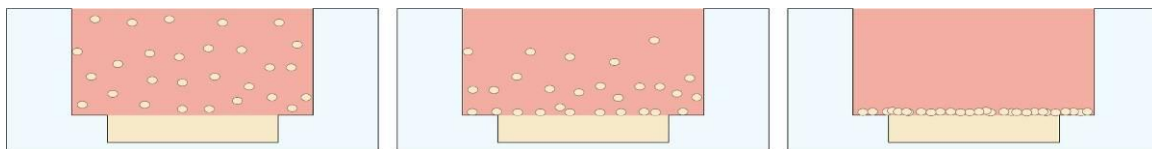

**Sinking process of cells. After some minutes all of the cells have fallen to the ground.**

The cross section of the well now shows two flat surfaces: the Matrigel<sup>®</sup> itself and the medium above. In comparison to standard open well formats no meniscus disturbs the excellent optical properties.

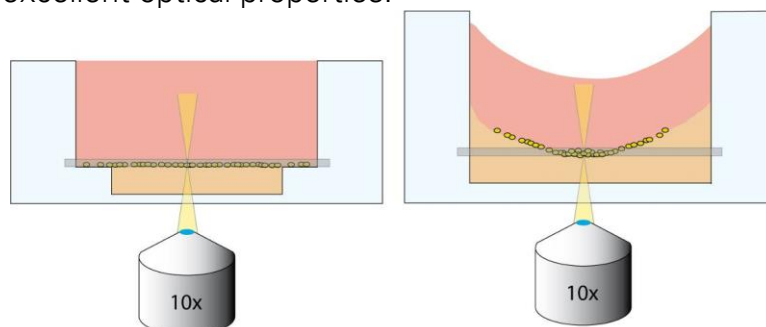

**Comparison between the flat surfaces of a well in  $\mu$ -Slide Angiogenesis and a well from a 96-well plate.**

### 5.1. Control the Right Cell Number!

To obtain reproducible results it is crucial to apply the correct cell number to the wells. To control this parameter, follow these steps:

- 1) Collect an image right after the settling of the cells, when they are still rounded up. Depending on your cell type this will be after 10-30 minutes.
- 2) Count the number of cells. This can be done e.g. with ImageJ ("Particle Analyzer" or manual "Cell Counting") or with an automated image analysis tool.
- 3) Extrapolate to the whole well growth surface (0.125 cm<sup>2</sup>).
- 4) Reject all the wells that do not show  $\pm$  10-20% of the target cell number.

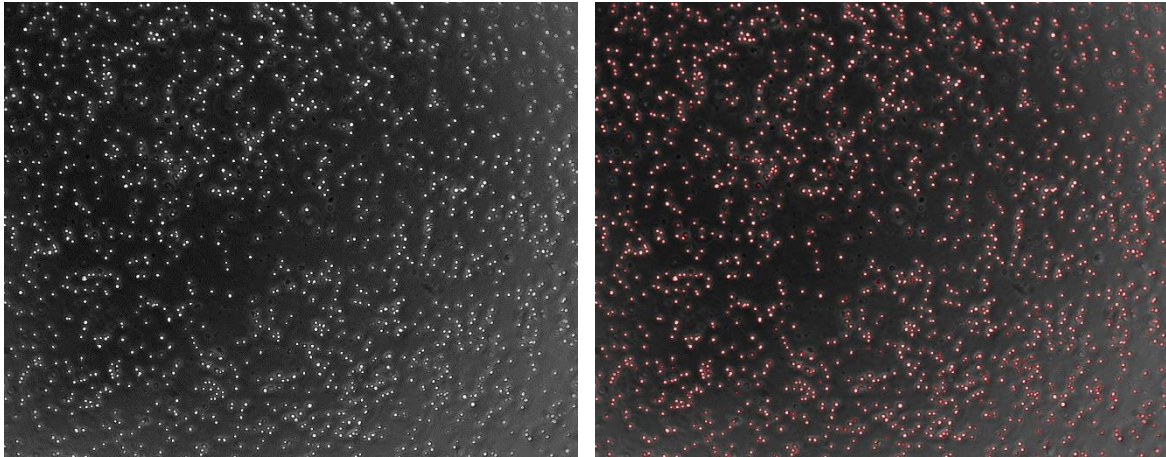

Cell Counting right after the cell seeding.

## 6. Observation on the Microscope

There are two possible ways to collect data on the microscope, manually or automatically. We recommend recording a time-lapse video to determine the time dependency and the characteristics (e.g., maximum and stable phase) of the curve. After this, single manual measurements are sufficient for investigating the effects of substances on tube formation.

### 6.1. Automatic Observation

Immediately after seeding the cells, position the slide on an inverted microscope equipped with an incubation chamber (e.g., the ibidi heating system). Choose the section you want to observe on your imaging system and then start a time-lapse recording. For HUVEC, we recommend a small magnification (4x or 10x) and a time interval of 5 minutes in between the single images. Use a software autofocus program to get sharp pictures over an elapsed time. It is possible that cells will migrate into the gel and change the focal plane.

## 6.2. Manual Observation

When you know the curve of the network formation, it is sufficient to collect images at only the points of interest. Incubate the slide inside of a humidity chamber in the incubator. Take it out at distinct time points to manually collect images on the microscope.

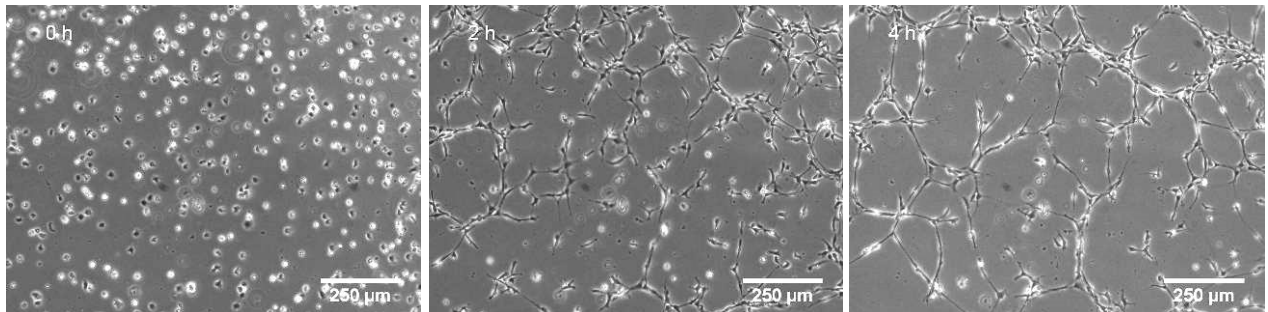

Time lapse images with a 10x magnification at 0, 2, and 4 hours.

## 7. Data Analysis and Interpretation

For optimal results and a fast and objective data analysis we recommend using our [ACAS Image Analysis System](#) – a web-based automated image analyzer. You can upload images to the platform and the results will be ready for download within minutes.

The images are analyzed based on different parameters, such as tube length, loops, or cell-covered area.

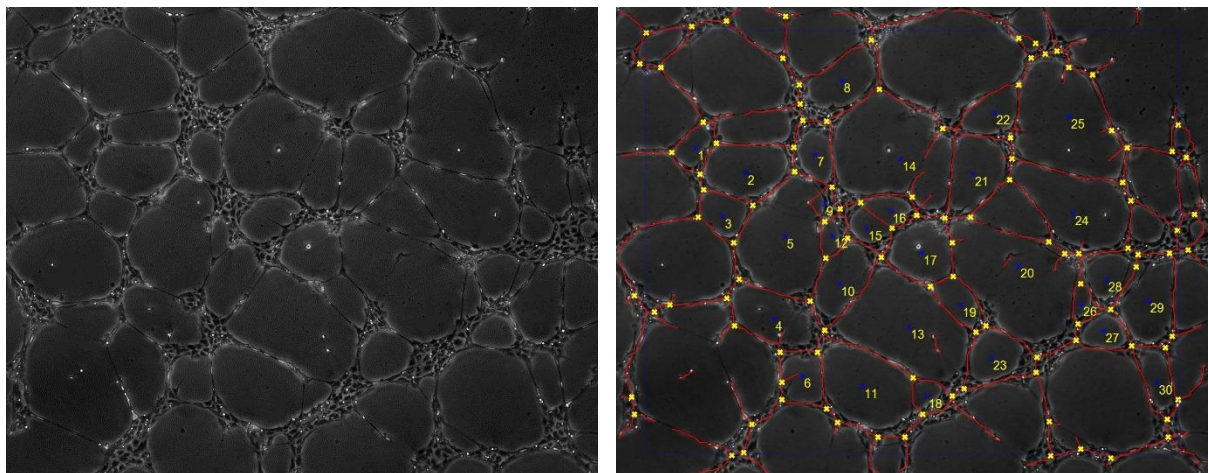

Resulting tube formation image - before and after ACAS Image Analysis.



## 8. Staining Protocol

Follow these steps:

- 1) Image the wells before staining. This provides a comparison of the cell pattern before and after staining.
- 2) Carefully discard the supernatant. Take care not to damage the gel or the cell network.
- 3) Add 50  $\mu$ l serum-free medium with diluted calcein (12.5  $\mu$ l calcein stock 1  $\mu$ g/ $\mu$ l) at a final concentration of 6.25  $\mu$ g/ml (1:160).
- 4) Incubate in the dark for 30 minutes at room temperature.
- 5) Wash with PBS three times. Rinse the PBS slowly over the side of the upper well. Don't pipette it directly onto the cells. Remove it from the other side of the well, so that it very gently rinses the cells.
- 6) Collect fluorescence images at 485 nm/ 529 nm.

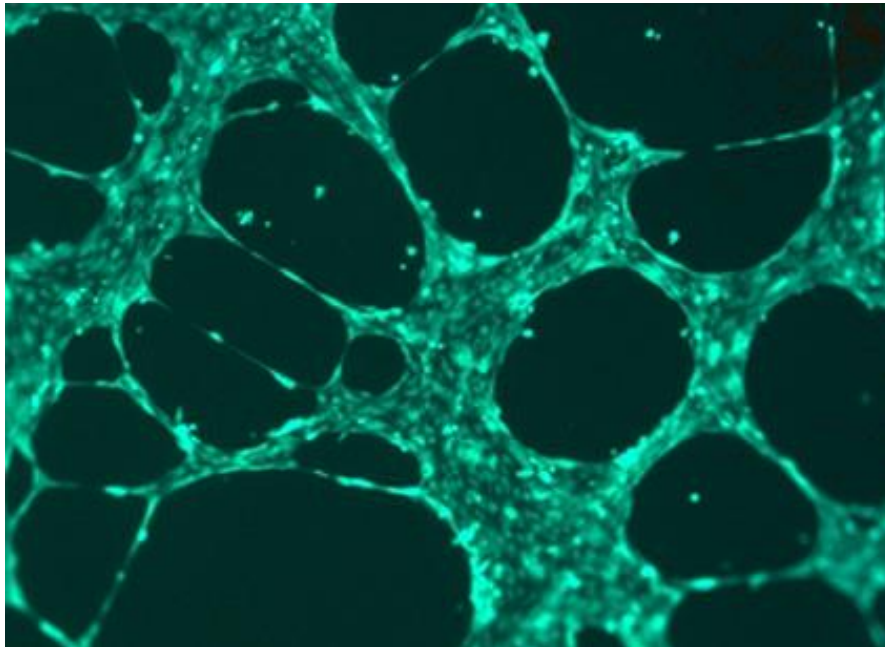

**HUVEC network stained with calcein (6.25  $\mu$ g/ml)**